

1SS314

SILICON EPITAXIAL PLANAR DIODE

Applications

- VHF Tuner Band Switch

PINNING

PIN	DESCRIPTION
1	Cathode
2	Anode

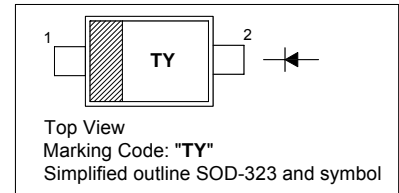

Absolute Maximum Ratings ($T_a = 25\text{ }^\circ\text{C}$)

Parameter	Symbol	Value	Unit
Reverse Voltage	V_R	30	V
Forward Current	I_F	100	mA
Junction Temperature	T_J	125	$^\circ\text{C}$
Storage Temperature Range	T_{stg}	- 55 to + 125	$^\circ\text{C}$

Characteristics at $T_a = 25\text{ }^\circ\text{C}$

Parameter	Symbol	Min.	Max.	Unit
Forward Voltage at $I_F = 2\text{ mA}$	V_F	-	0.85	V
Reverse Current at $V_R = 15\text{ V}$	I_R	-	0.1	μA
Reverse Voltage at $I_R = 1\text{ }\mu\text{A}$	V_R	30	-	V
Total Capacitance at $V_R = 6\text{ V}$, $f = 1\text{ MHz}$	C_T	-	1.2	pF
Series Resistance at $I_F = 2\text{ mA}$, $f = 100\text{ MHz}$	r_s	-	0.9	Ω

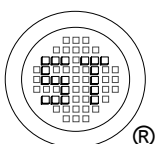

SEMTECH ELECTRONICS LTD.

(Subsidiary of Sino-Tech International Holdings Limited, a company
listed on the Hong Kong Stock Exchange, Stock Code: 724)



Dated : 01/09/2005

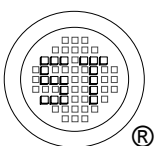
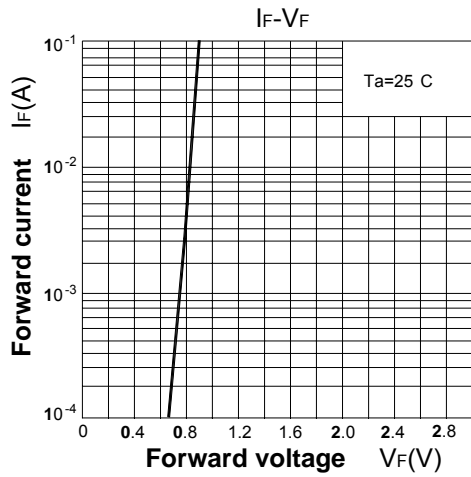
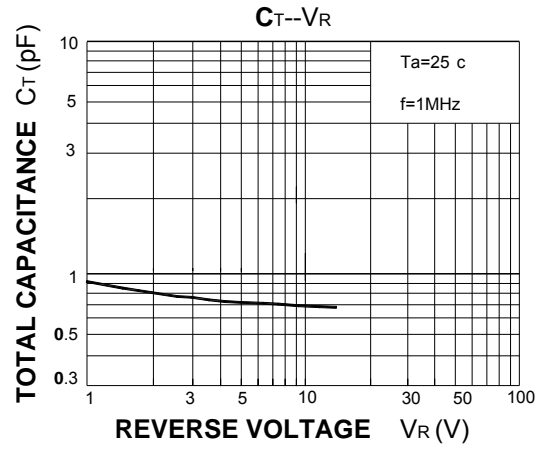
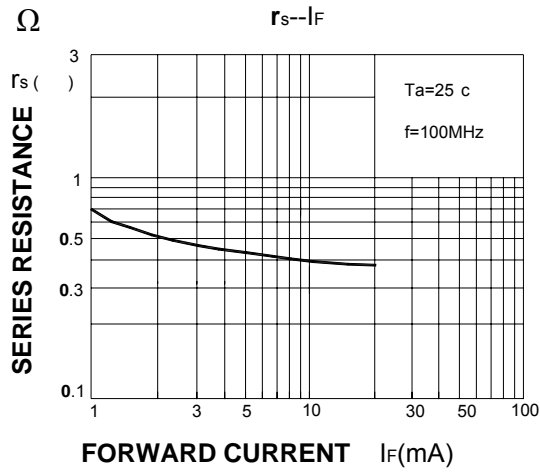

SEMTECH ELECTRONICS LTD.
 (Subsidiary of Sino-Tech International Holdings Limited, a company listed on the Hong Kong Stock Exchange, Stock Code: 724)



PACKAGE OUTLINE

Plastic surface mounted package; 2 leads

SOD-323

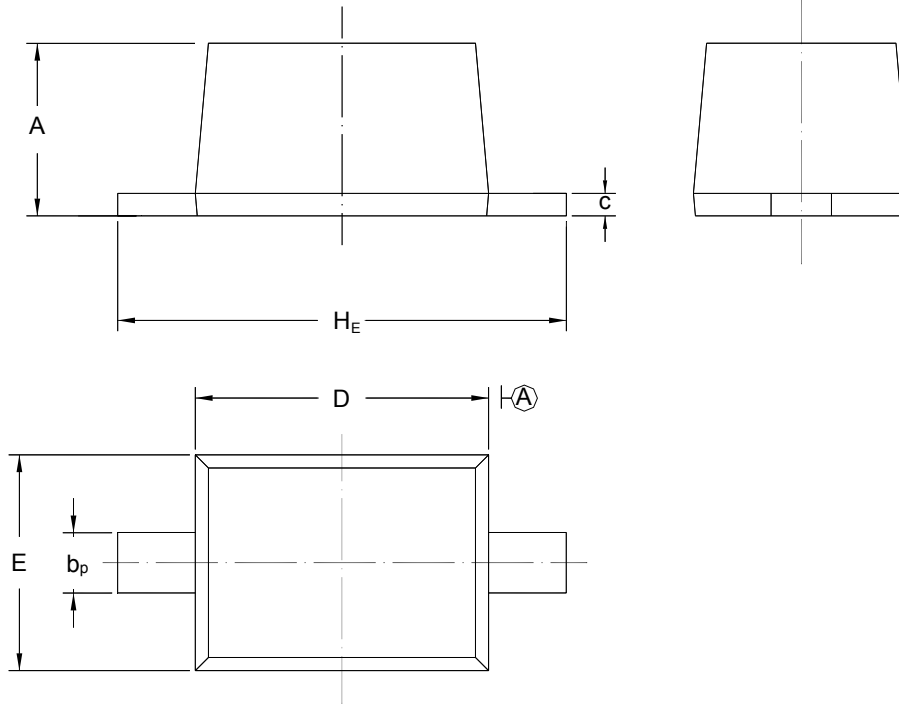

UNIT	A	b_p	C	D	E	H_E
mm	1.10 0.80	0.40 0.25	0.15 0.00	1.80 1.60	1.35 1.15	2.80 2.30

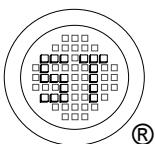

SEMTECH ELECTRONICS LTD.
 (Subsidiary of Sino-Tech International Holdings Limited, a company
 listed on the Hong Kong Stock Exchange, Stock Code: 724)



Dated : 01/09/2005