

BA782

Band Switching Diode

Mechanical Data:

Case: SOD-123 plastic case

PINNING

PIN	DESCRIPTION
1	Cathode
2	Anode

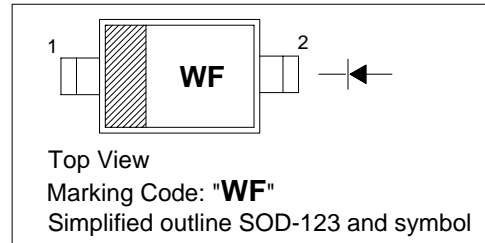

Description:

Silicon Epitaxial Planar Diode Switches

For electric band switching in radio and TV tuners in the frequency range of (50 to 1000) MHz.

Absolute Maximum Ratings (Ta=25°C)

Parameter	Symbol	Limits	Unit
Reverse voltage	V_R	35	V
Forward continuous current	I_F	100	mA
Junction temperature	T_J	125	°C
Storage temperature	T_{stg}	-55 to +125	°C

Electrical Characteristics (Ta=25°C)

Parameter	Symbol	Min	Typ	Max	Unit	Conditions
Forward voltage	V_F	-	-	1.0	V	$I_F=100\text{mA}$
Leakage current	I_R	-	-	50	nA	$V_R=20\text{V}$
Capacitance	C_{tot}	-	-	1.5 1.25	pF	$V_R=1\text{V}, f=1\text{MHz}$ $V_R=3\text{V}, f=1\text{MHz}$
Dynamic forward resistance	r_f	-	-	0.7 0.5	Ω	$f=(50 \text{ to } 1000)\text{MHz}, I_F=3\text{mA}$ $f=(50 \text{ to } 1000)\text{MHz}, I_F=10\text{mA}$
Series inductance across case	L_S	-	2.5	-	nH	-

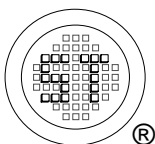

SEMTECH ELECTRONICS LTD.

(Subsidiary of Sino-Tech International Holdings Limited, a company listed on the Hong Kong Stock Exchange, Stock Code: 724)



ISO/TS 16949 : 2002
Certificate No. 05103



ISO 14001:2004
Certificate No. 7116



ISO 9001:2000
Certificate No. 0506098

Dated : 11/10/2004

Typical Characteristics ($T_{amb} = 25\text{ }^{\circ}\text{C}$ unless otherwise specified)

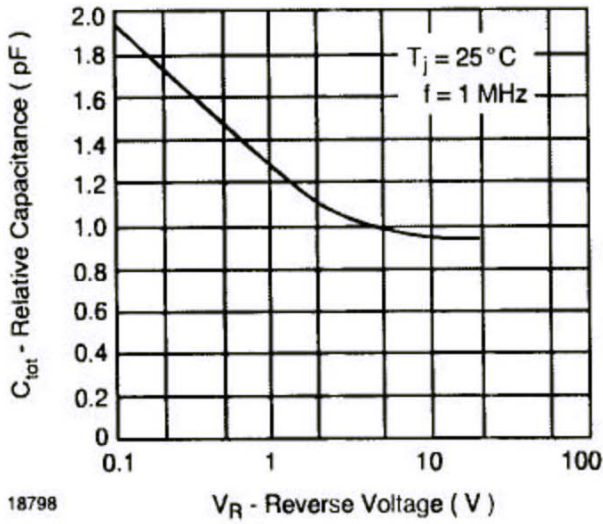

Figure 1. Capacitance vs. Reverse Voltage

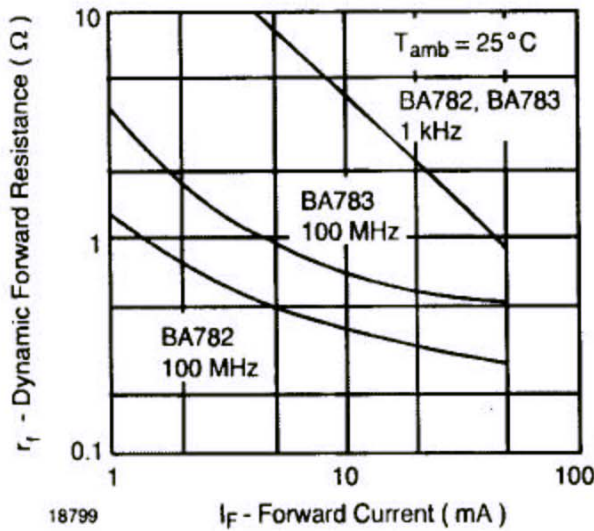
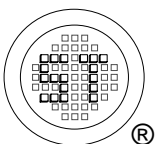

Figure 2. Dynamic Forward Resistance vs. Forward Current



SEMTECH ELECTRONICS LTD.

(Subsidiary of Sino-Tech International Holdings Limited, a company listed on the Hong Kong Stock Exchange, Stock Code: 724)



ISO/TS 16949 : 2002
Certificate No. 05103



ISO 14001:2004
Certificate No. 71116



ISO 9001:2000
Certificate No. 0506098

PACKAGE OUTLINE

Plastic surface mounted package; 2 leads

SOD-123

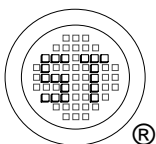
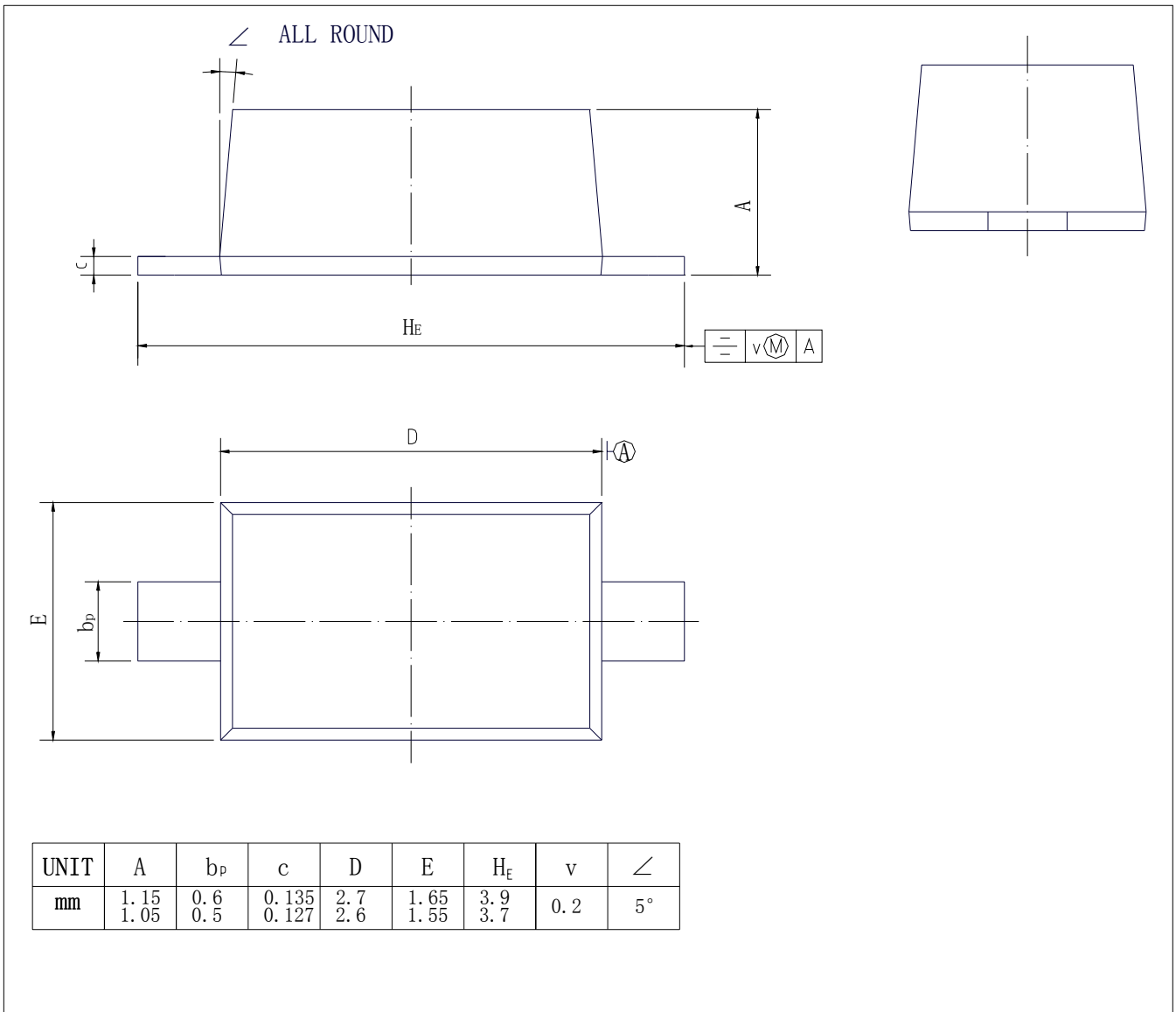

SEMTECH ELECTRONICS LTD.
 (Subsidiary of Sino-Tech International Holdings Limited, a company
 listed on the Hong Kong Stock Exchange, Stock Code: 724)



ISO/TS 16949 : 2002
 Certificate No. 05103



ISO 14001:2004
 Certificate No. 7116



ISO 9001:2000
 Certificate No. 0506098

Dated : 11/10/2004